

SmartAX EA5800

Full-service distributed architecture OLT Building a convergence access network that is green, ultra-broadband, and intelligent

- The EA5800 series multi-service access device relies on a distributed architecture, and it provides a unified carrying platform for multiple services, such as broadband, wireless, video, and monitoring.
- The EA5800 provides GPON, 10GE/GE access, and supports POL, FTTH, FTTB, and FTTC network construction modes. It carries all services over one fiber network, simplifying network architecture and reducing OPEX.
- The EA5800 supports capacities for large, medium, and small products, meeting requirements in different scenarios.

Distributed Architecture

Service processing, previously centered on the control board, is now distributed to every service board. The system switching capacity and performance are improved, with the throughput of a single slot reaching up to 100 Gbit/s. This ensures smooth services and supports faster HD video startup and channel zapping.

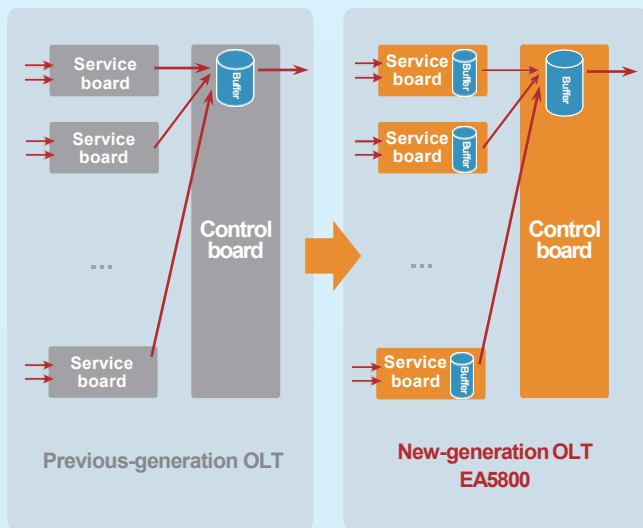

High Reliability

Type B/Type C dual-homing implements remote disaster recovery backup protection by configuring two control boards and two power boards for redundancy backup. Additionally, multiple uplinks are configured for protection.

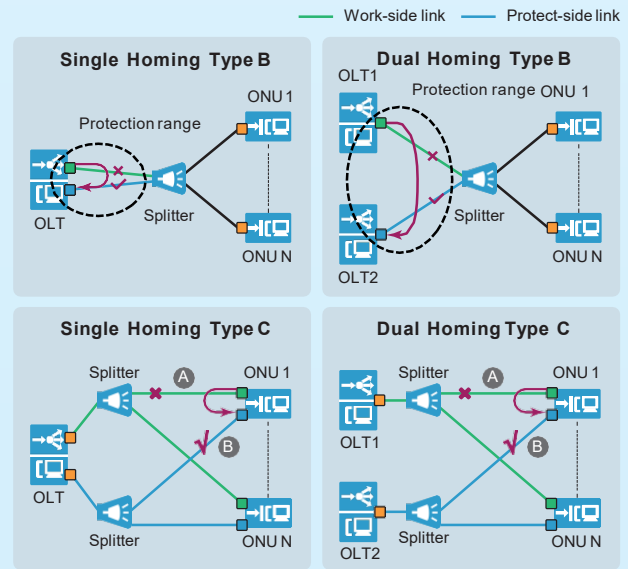

ISSU

In distributed architecture, control and forwarding are isolated, ensuring that services are not interrupted during device upgrades. This also reduces user complaints. Devices can even be upgraded during working hours.

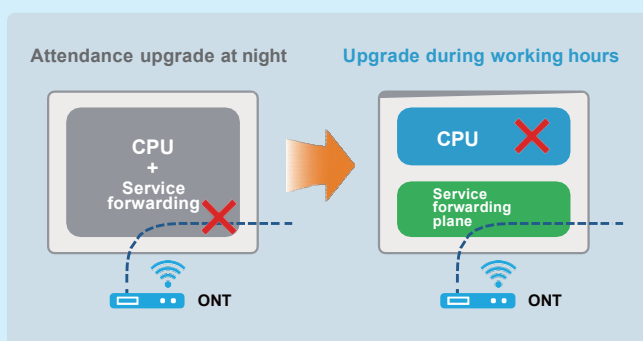





Integrated Multiple Access Technologies

Supports PON and P2P access, and carries all services over one fiber network, simplifying network architecture and reducing investments.



Product Specification

Product Indicator				
	EA5800-X17 11 U (height), 21 inch (width)	EA5800-X15 11 U (height), 19 inch (width)	EA5800-X7 6 U (height), 19 inch (width)	EA5800-X2 2 U (height), 19 inch (width)
Control board switching capacity	3.6 Tbit/s			480 Gbit/s
Maximum bandwidth perslot	100 Gbit/s			80 Gbit/s
Number of concurrent 4K video users	16000		8000	2000
Power supply mode	DC power supply (dual for backup)			· DC power supply (dual for backup) · AC power supply + battery
Rated voltage	-48V/-60V			· DC power supply: -48 V/-60 V · AC power supply: 110 V/220 V
Ambient temperature	-40°C to +65°C* (normal operation) Minimum startup temperature: -25°C			*65°C indicates the temperature of the air intake vent of the service subrack.
GPON ports	16*17 = 272	16*15 = 240	16*7 = 112	16*2 = 32
10GE/GE ports	8*17 = 136	8*15 = 120	8*7 = 56	8*2 = 16
10GE/GE upstream ports (control board for upstream transmission)	4*2 = 8	4*2 = 8	4*2 = 8	4*2 = 8

Why Huawei

Huawei EA5800 full-service distributed OLT provides ultra-broadband, stable, and reliable service experience for home and enterprise users. It carries all services over one fiber network, avoiding repeated network construction, simplifying networks, and reducing O&M difficulty. Huawei, as a leader in the optical access field, ranked first in PON and NG GPON market share for several consecutive years. 82% of global top 50 carriers choose Huawei's optical access solution. Huawei is dedicated to build one efficient, simple, and ultra-broadband access network, improving customers' service experience.

More

EA5800:

<http://e.huawei.com/en/products/fixed-network/access/olt/ea5800>

Access products:

<http://e.huawei.com/en/products/fixed-network/access>

Huawei products:

<http://support.huawei.com/enterprise>



EA5800



Access Products



Huawei Enterprise Support

Copyright © Huawei Technologies Co.,Ltd. 2019. All rights reserved.

General disclaimer

The information in this document may contain predictive statements including, without limitation, statements regarding the future financial and operating results, future product portfolio, new technology, etc. there are a number of factors that could cause actual results and developments to differ materially from those expressed or implied in the predictive statements. Therefore, such information is provided for reference purpose only and constitutes neither an offer nor an acceptance. Huawei may change the information at any time without notice.

<http://www.huawei.com>